

REGULAR LENGTH WELDON SHANK CENTER CUTTING.

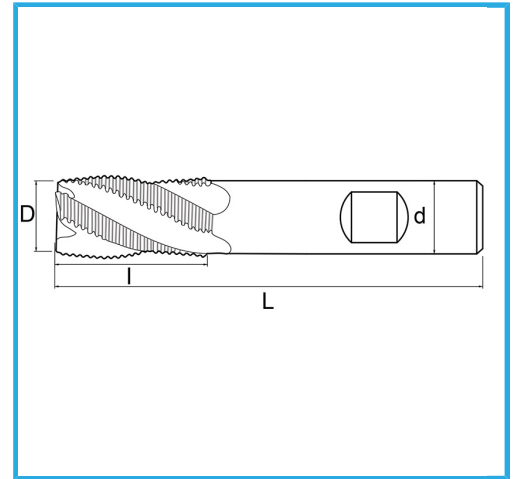

D	14 mm
d	12 mm
l	26 mm
Z	4
L	83 mm
Gross weight	0,07 kg
EAN Code	8012667217334



Box



External



844/B



HSS

-



TIN

-