

ZENTRALSCHNITT, ZYLINDERSCHAFT WELDON-AUFSATZ, NORMALE
BAUREIHE.

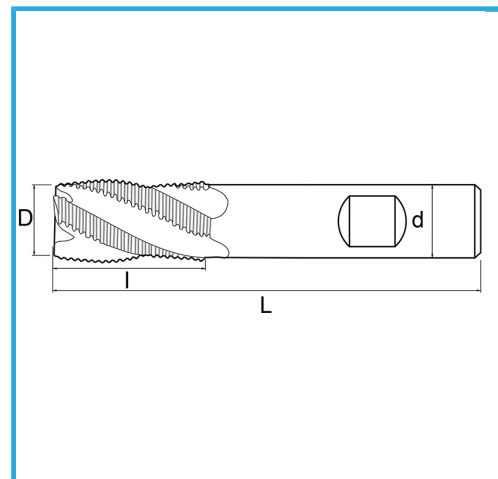

D	16 mm
d	16 mm
l	32 mm
Z	4
L	92 mm
Bruttogewicht	0,13 kg
EAN-Code	8012667217341



Box



Extern



844/B



-



-