

ZENTRALSCHNITT, ZYLINDERSCHAFT WELDON-AUFSATZ, NORMALE  
BAUREIHE.

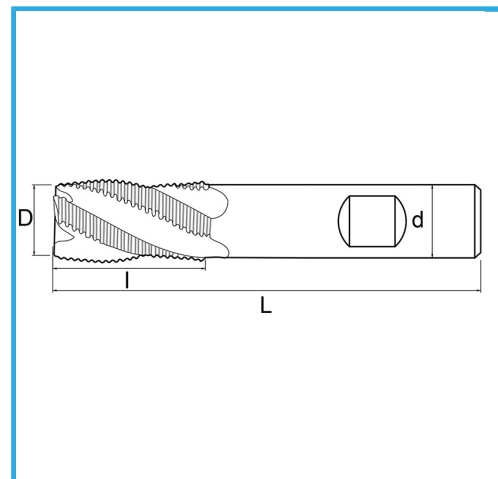

D	22 mm
d	20 mm
l	38 mm
Z	4
L	104 mm
<b>Bruttogewicht</b>	0,24 kg
<b>EAN-Code</b>	8012667217365



Box



Extern



844/B



HSS

-



TIN

-