

REGULAR LENGTH WELDON SHANK CENTER CUTTING.

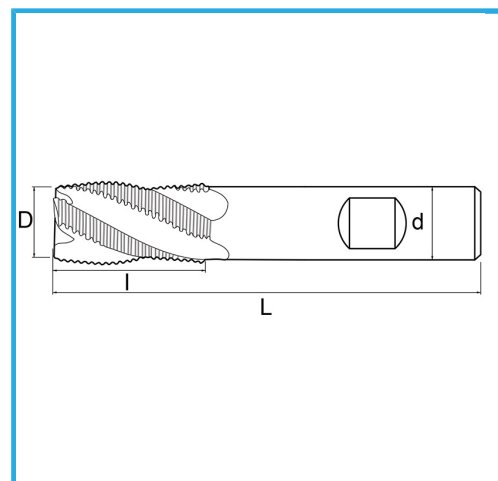

D	22 mm
d	20 mm
l	38 mm
Z	4
L	104 mm
Gross weight	0,24 kg
EAN Code	8012667217365



Box



External



844/B



HSS

-



TIN

-