

MIT GESCHLIFFENEN KANTEN UND AUS DEM VOLLEN GEFRÄSTEN
NUTEN ZUM VIBRATIONSFREIEN KONISCHEN ANSENKEN.

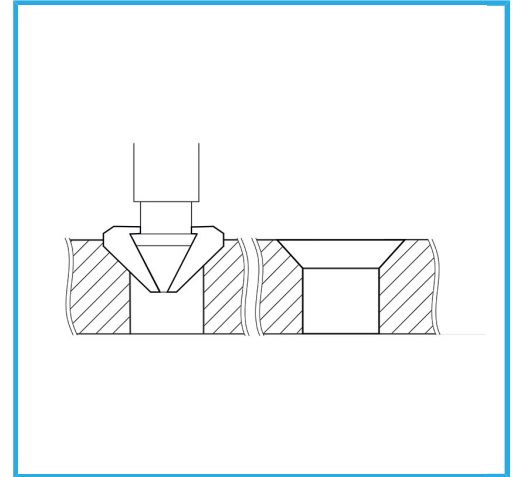

max. ø	10,4 mm
Schrauben M	5
Schaft	Ø 6 mm
Bruttogewicht	0,01 kg
EAN-Code	8012667142216

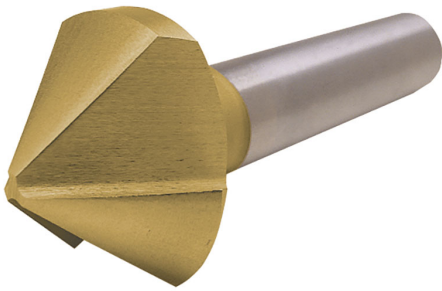

Box

HSS

-



TiN

-



90°



Extern