

WITH GROUND EDGES AND GROOVES MACHINED FROM SOLID, TO PERFORM CONICAL COUNTERSINKS WITHOUT VIBRATIONS.

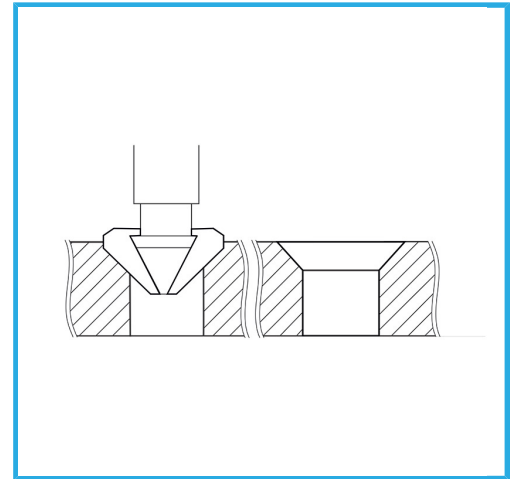

Ø max	12,4 mm
Screws M	6
Shank	Ø 8 mm
Gross weight	0,03 kg
EAN Code	8012667004637

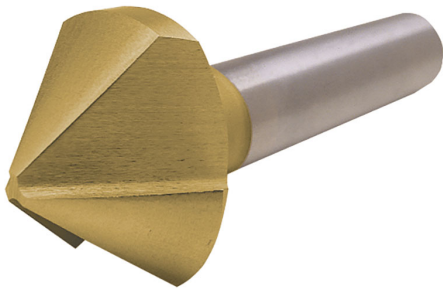

Box



HSS

-



TiN

-



90°



External