

MIT GESCHLIFFENEN KANTEN UND AUS DEM VOLLEN GEFRÄSTEN
NUTEN ZUM VIBRATIONSFREIEN KONISCHEN ANSENKEN.

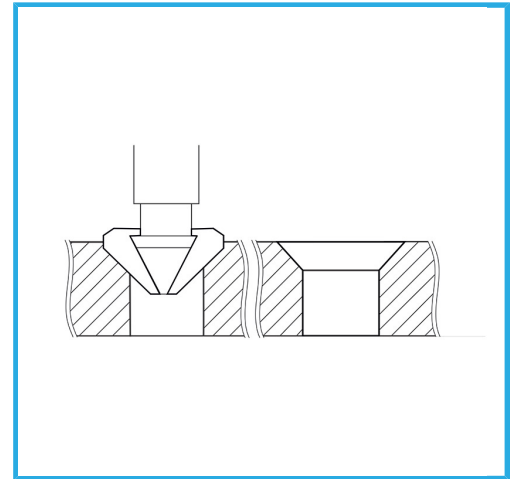

max. ø	16,5 mm
Schrauben M	8
Schaft	Ø 10 mm
Bruttogewicht	0,04 kg
EAN-Code	8012667142223

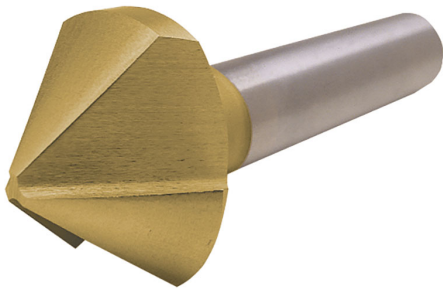

Box

HSS

-



TiN

-



90°



Extern