

WITH GROUND EDGES AND GROOVES MACHINED FROM SOLID, TO PERFORM CONICAL COUNTERSINKS WITHOUT VIBRATIONS.

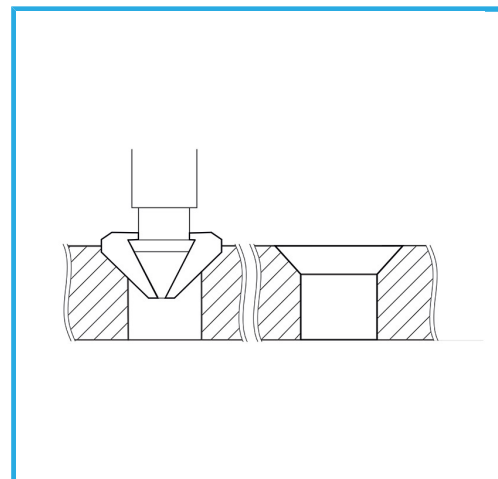

Ø max	25 mm
Screws M	12
Shank	Ø 10 mm
Gross weight	0,07 kg
EAN Code	8012667142247

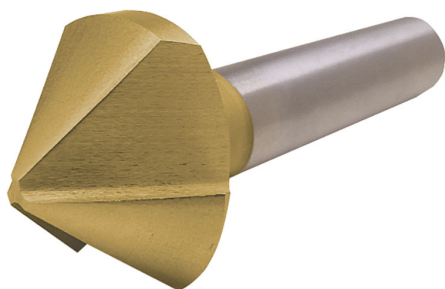

Box



HSS

-



TiN

-



90°



External