

MIT GESCHLIFFENEN KANTEN UND AUS DEM VOLLEN GEFRÄSTEN NUTEN ZUM VIBRATIONSFREIEN KONISCHEN ANSENKEN.

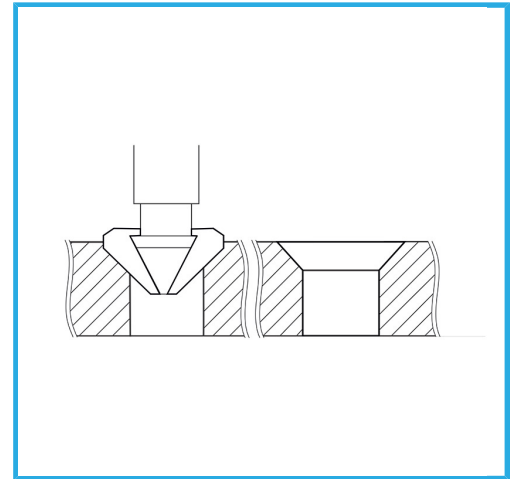

max. ø	28 mm
Schrauben M	14
Schaft	Ø 12 mm
Bruttogewicht	0,10 kg
EAN-Code	8012667142254

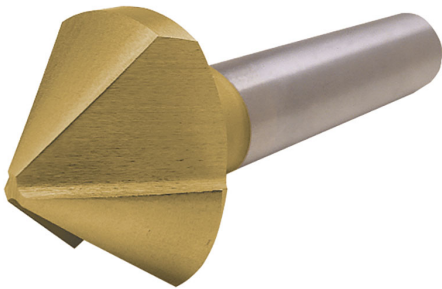

Box

HSS

-



TiN

-



90°



Extern