

ISOMETRISCHES GEWINDE GROBE TEILUNG.

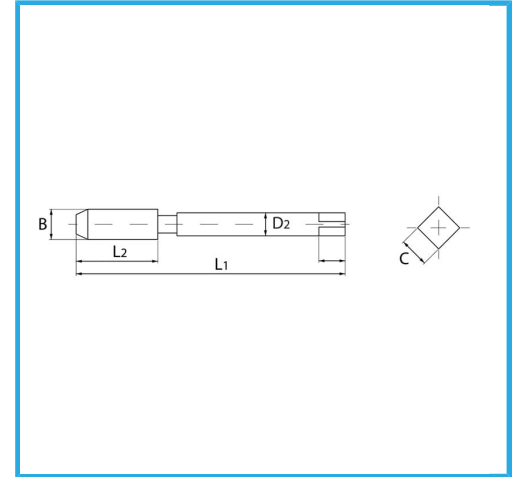

B	M12 x 1,75 mm
L2	29 mm
L1	110 mm
D2	9 mm
C	7 mm
Bruttogewicht	0,06 kg
EAN-Code	8012667141615

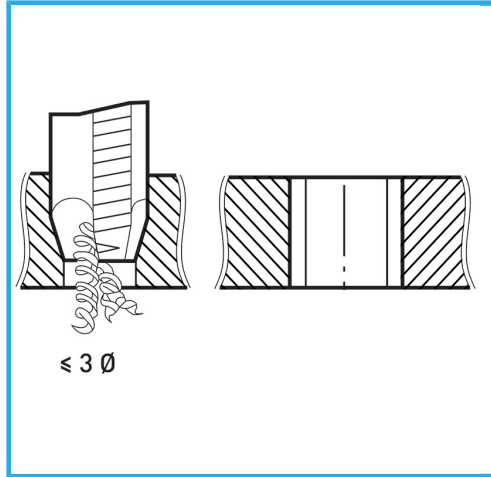

Box



HSS-G



HV=750



Extern



376/B