

ART. M002/12
MACHOS DE MAQUINA CON BANURAS RECTAS PARA
AGUJEROS PASANTES CON ENTRADA CORREGIDA



PASO GRUESO DE HILO ISOMÉTRICO.



€13,50

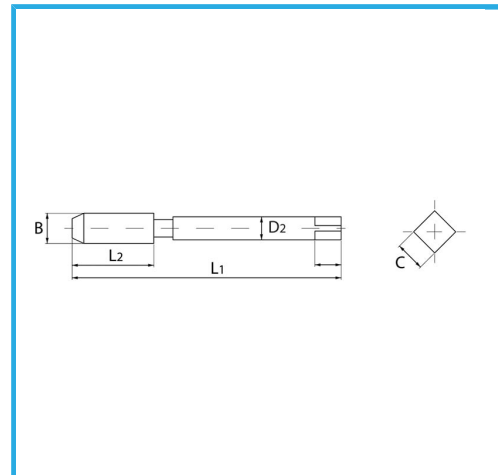
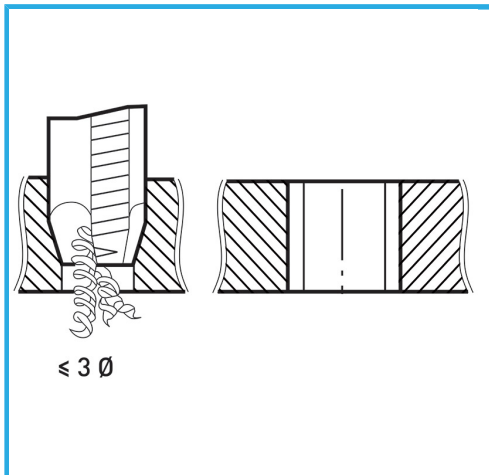

B	M12 x 1,75 mm
L2	29 mm
L1	110 mm
D2	9 mm
C	7 mm
Peso bruto	0,06 kg
Codigo de barras	8012667141615



Caja



HSS-G



HV=750



Externa



376/B