

ISOMETRISCHES GEWINDE GROBE TEILUNG.

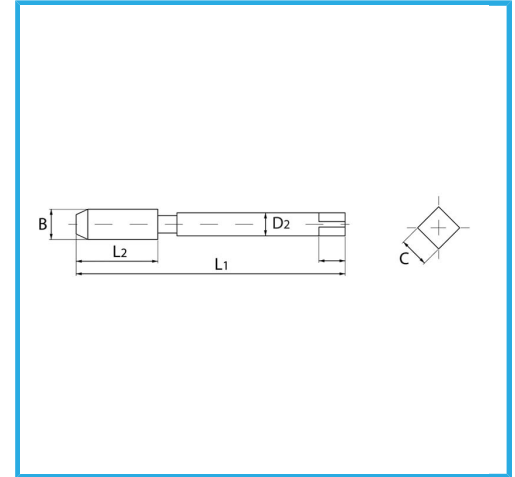

B	M14 x 2 mm
L2	30 mm
L1	110 mm
D2	11 mm
C	9 mm
Bruttogewicht	0,08 kg
EAN-Code	8012667141622

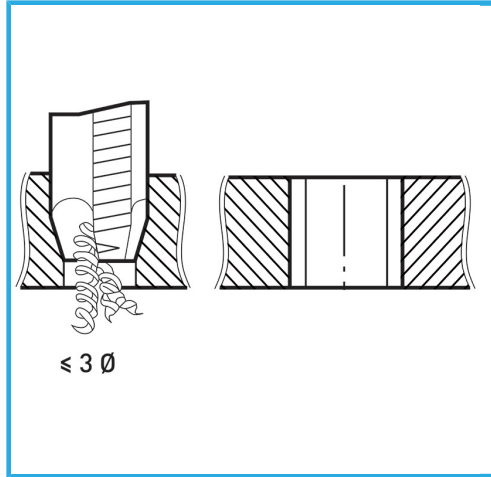

Box



HSS-G



HV=750



Extern



376/B