

ISOMETRISCHES GEWINDE GROBE TEILUNG.

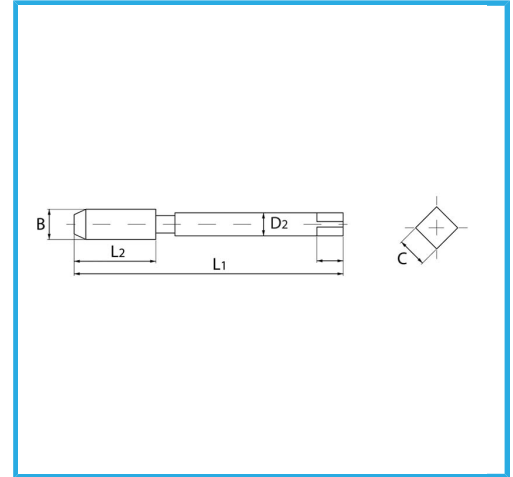

B	M16 x 2 mm
L2	32 mm
L1	110 mm
D2	12 mm
C	9 mm
Bruttogewicht	0,10 kg
EAN-Code	8012667141639

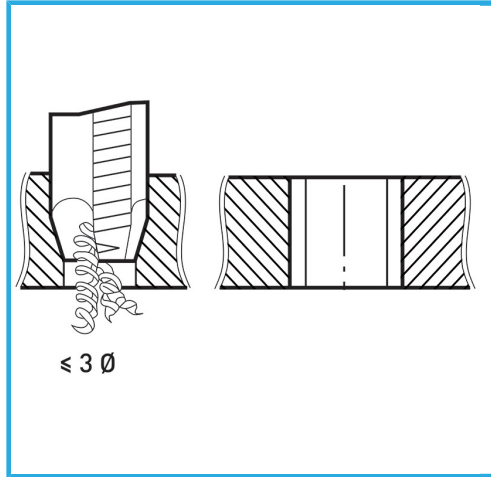

Box



HSS-G



HV=750



Extern



376/B