

ART. M002/16V
MACHINE TAPS STRAIGHT FLUTE SPIRAL POINTED FOR THROUGH HOLES

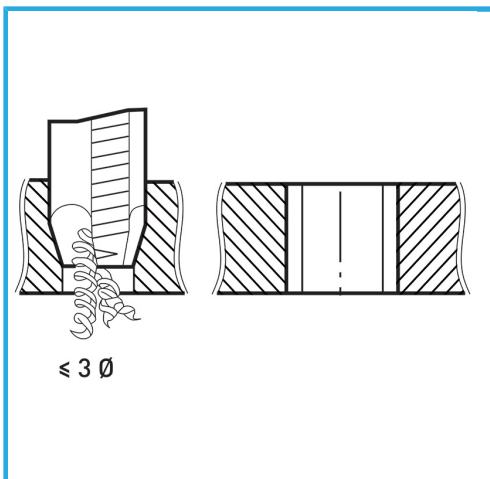

ISOMETRIC THREAD COARSE PITCH. THE VAPORIZATION TREATMENT INCREASES THE SURFACE HARDNESS AND WEAR RESISTANCE BY REDUCING THE...



B	M16 x 2 mm
L2	32 mm
L1	110 mm
D2	12 mm
C	9 mm
Gross weight	0,10 kg
EAN Code	8012667257422



Box



Vaporized



HV=750



External



376/B



HSS-G

-