

ISOMETRISCHES GEWINDE GROBE TEILUNG.

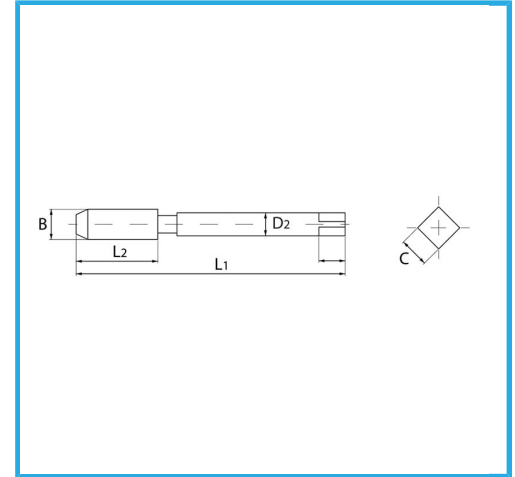

B	M18 x 2,5 mm
L2	34 mm
L1	125 mm
D2	14 mm
C	11 mm
Bruttogewicht	0,17 kg
EAN-Code	8012667141646

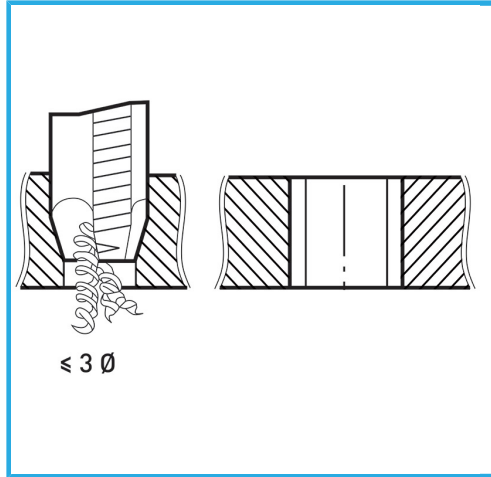

Box



HSS-G



HV=750



Extern



376/B