

ART. M002/27
MACHINE TAPS STRAIGHT FLUTE SPIRAL POINTED FOR
THROUGH HOLES

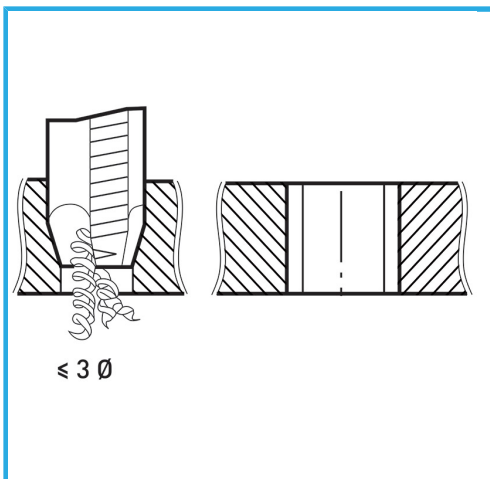

ISOMETRIC THREAD COARSE PITCH.



B	M27 x 3 mm
L2	38 mm
L1	160 mm
D2	20 mm
C	16 mm
Gross weight	0,41 kg
EAN Code	8012667257163



Box



HSS-G



HV=750



External



376/B