

**ART. M002/30**  
MACHINE TAPS STRAIGHT FLUTE SPIRAL POINTED FOR  
THROUGH HOLES

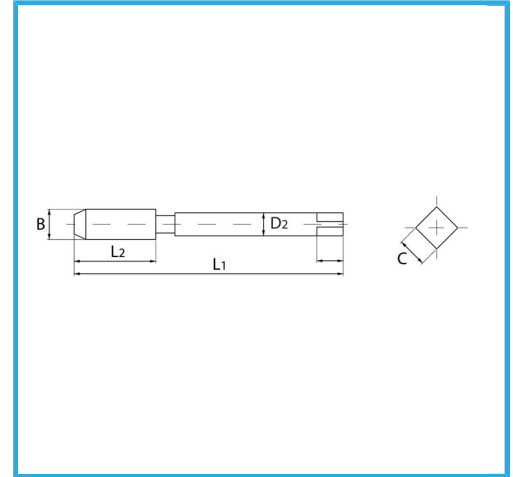

ISOMETRIC THREAD COARSE PITCH.

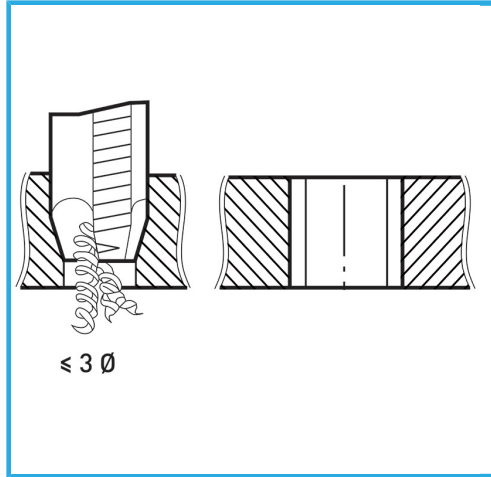

B	M30 x 3,5 mm
L2	45 mm
L1	180 mm
D2	22 mm
C	18 mm
Gross weight	0,56 kg
EAN Code	8012667257170



Box



HSS-G



HV=750



External



376/B