

ISOMETRIC THREAD COARSE PITCH - REINFORCED SHANK, THE VAPORIZATION TREATMENT INCREASES THE SURFACE HARDNESS AND WEAR RESISTANCE...

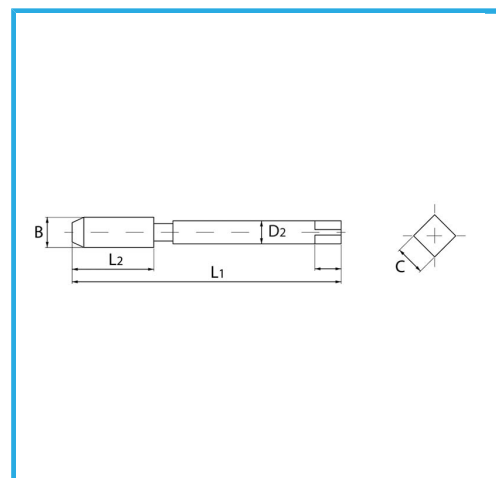

B	M8 x 1,25 mm
L2	22 mm
L1	90 mm
D2	8 mm
C	6.2 mm
Gross weight	0,03 kg
EAN Code	8012667257262

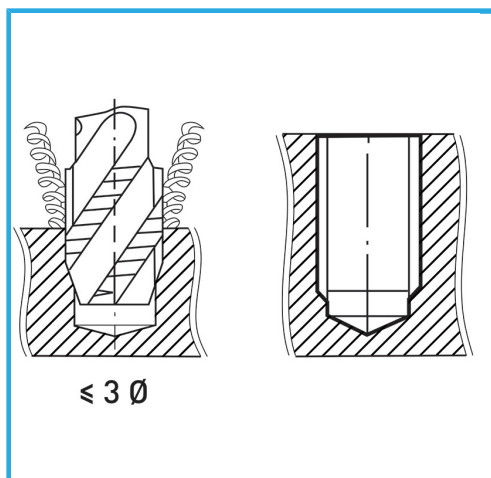

Box



HSS-G

-



Vaporized



HV=750



External



371/C