

ISOMETRIC THREAD COARSE PITCH - REINFORCED SHANK, THE VAPORIZATION TREATMENT INCREASES THE SURFACE HARDNESS AND WEAR RESISTANCE...

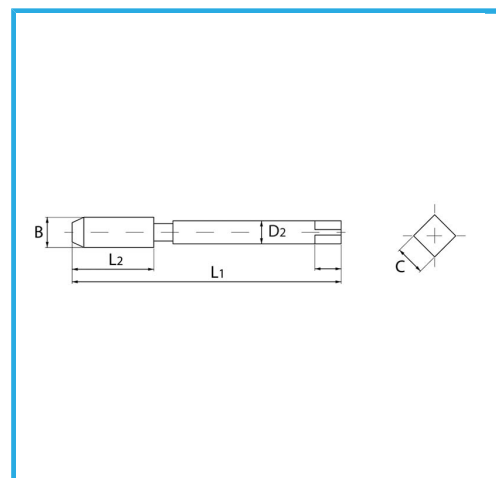

<b>B</b>	M10 x 1,5 mm
<b>L2</b>	24 mm
<b>L1</b>	100 mm
<b>D2</b>	10 mm
<b>C</b>	8 mm
<b>Gross weight</b>	0,05 kg
<b>EAN Code</b>	8012667257279

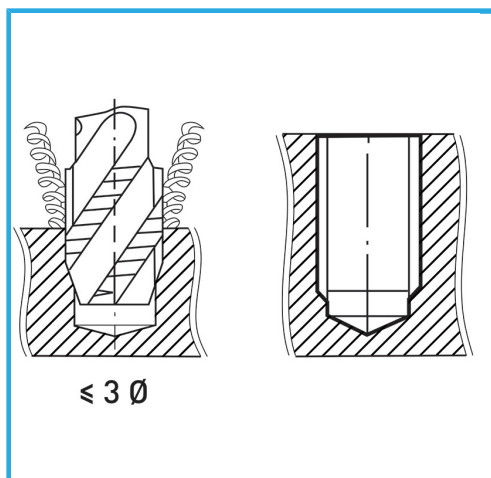

Box



HSS-G

-



Vaporized



HV=750



External



371/C