

ISOMETRISCHES GEWINDE GROBE TEILUNG.

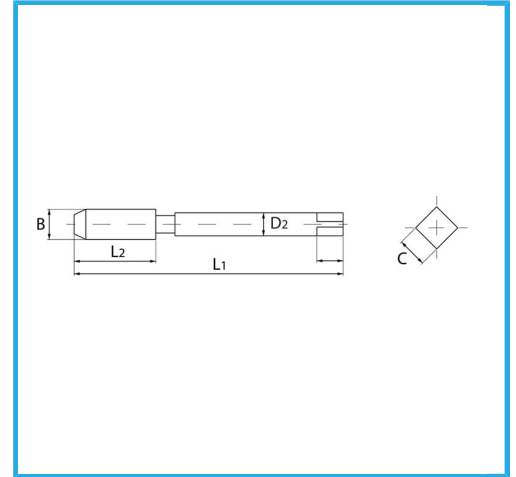

B	M14 x 2 mm
L2	30 mm
L1	110 mm
D2	11 mm
C	9 mm
Bruttogewicht	0,05 kg
EAN-Code	8012667141721

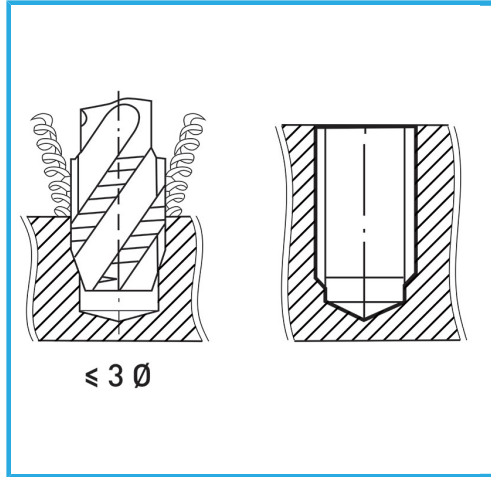

Box



HV=750



Extern



376/C



HSS-G

-