

ISOMETRISCHES GEWINDE GROBE TEILUNG.

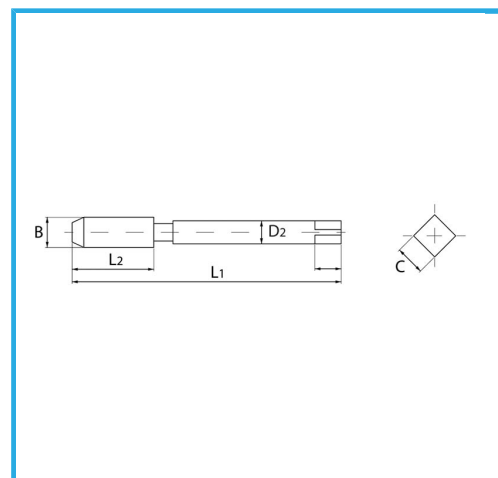

B	M20 x 2,5 mm
L2	34 mm
L1	140 mm
D2	16 mm
C	12 mm
Bruttogewicht	0,05 kg
EAN-Code	8012667141752

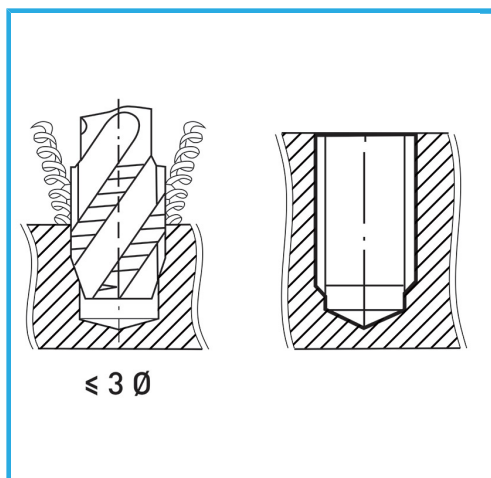

Box



HV=750



Extern



376/C



HSS-G

-