

ISOMETRIC THREAD COARSE PITCH. THE VAPORIZATION TREATMENT INCREASES THE SURFACE HARDNESS AND WEAR RESISTANCE BY REDUCING THE...

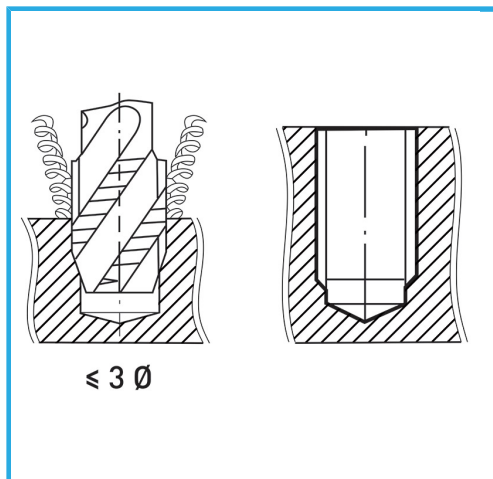

B	M20 x 2,5 mm
L2	34 mm
L1	140 mm
D2	16 mm
C	12 mm
Gross weight	0,23 kg
EAN Code	8012667257330



Box



HSS-G

-



Vaporized



HV=750



External



376/C