

ISOMETRISCHES GEWINDE GROBE TEILUNG.

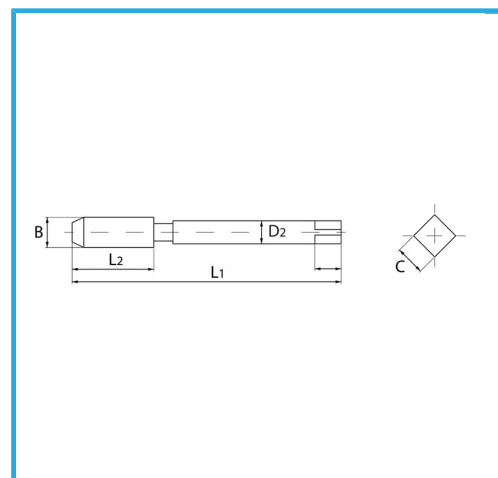

B	M30 x 3,5 mm
L2	45 mm
L1	180 mm
D2	22 mm
C	18 mm
Bruttogewicht	0,49 kg
EAN-Code	8012667257217

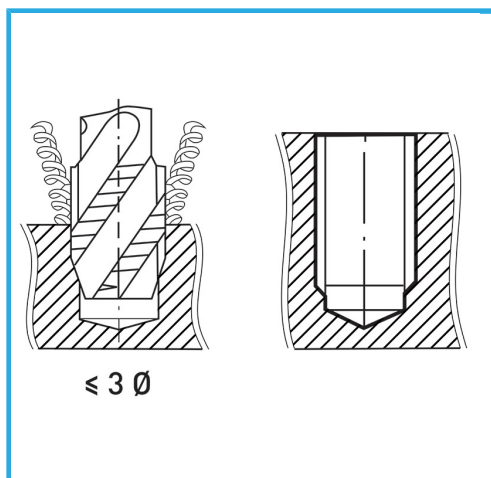

Box



HV=750



Extern



376/C



HSS-G

-