

ISOMETRISCHES GEWINDE GROBE TEILUNG - VERSTÄRKTER.

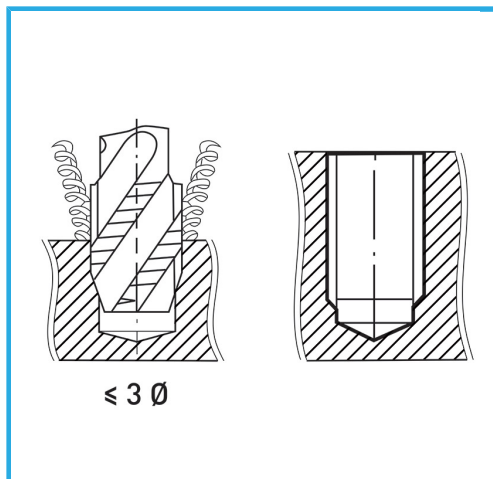

B	M5 x 0,80 mm
L2	18 mm
L1	74 mm
D2	6 mm
C	4.9 mm
Bruttogewicht	0,01 kg
EAN-Code	8012667141776



Box



HSS-G



HV=750



Extern



371/C