

ART. M003/5
MACHOS DE MÁQUINA CON RANURAS HELICOIDALES DE 35° A
LA DERECHA PARA AGUJEROS CIEGOS



PASO GRUESO DE HILO ISOMÉTRICO - VÁSTAGO REFORZADO.



€6,80

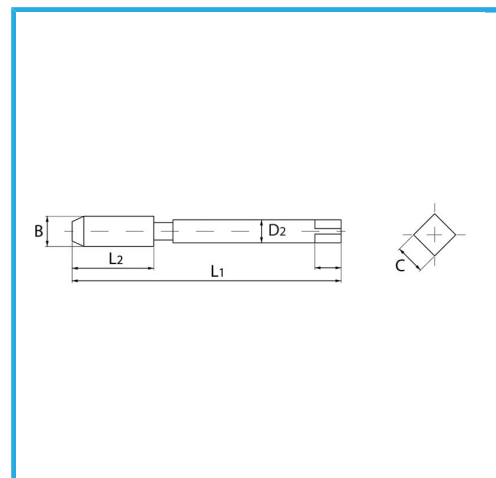
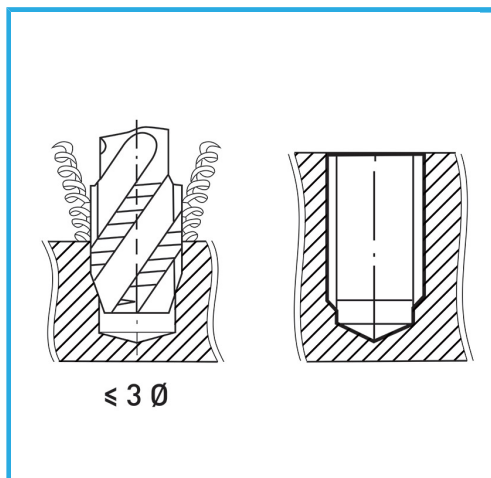

B	M5 x 0,80 mm
L2	18 mm
L1	74 mm
D2	6 mm
C	4.9 mm
Peso bruto	0,01 kg
Codigo de barras	8012667141776



Caja



HSS-G



HV=750



Externa



371/C