

GEEIGNET ZUR GEWINDEREGENERATION ODER UM SEHR WIDERSTANDSFÄHIGES GEWINDESCHNEIDEN IN WEICHE MATERIALIEN ZU ERHALTEN.

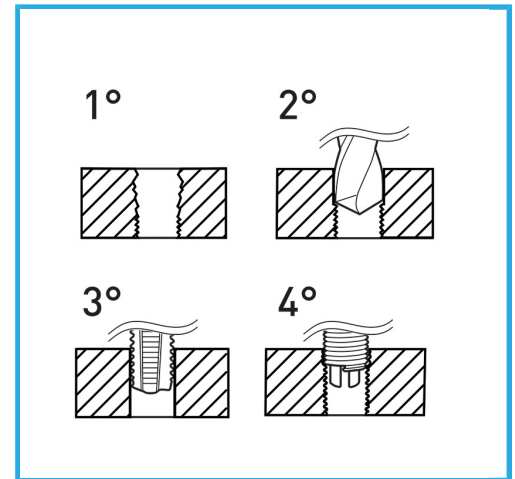

Gewindeinsatz	M5
Bohrer	5,2 mm
Gewindebohrer	x M5
Handgriff	2
Bruttogewicht	0,41 kg
EAN-Code	8012667249939



Aufhängbar

HSS

INOX