

INDICADO PARA LA REGENERACIÓN DE ROSCAS O PARA OBTENER ROSCADOS MUY RESISTENTES EN MATERIALES BLANDOS.

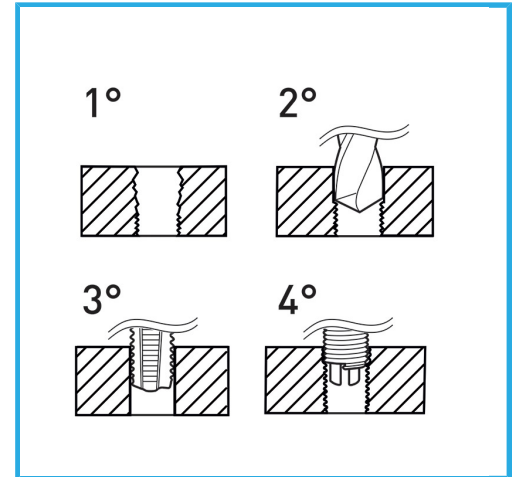

€28,50



Rosca inserta	M5
Broca	5,2 mm
Macho	x M5
Mango	2
Peso bruto	0,41 kg
Codigo de barras	8012667249939



Colgante

HSS



INOX