

GEEIGNET ZUR GEWINDEREGENERATION ODER UM SEHR WIDERSTANDSFÄHIGES GEWINDESCHNEIDEN IN WEICHE MATERIALIEN ZU ERHALTEN.

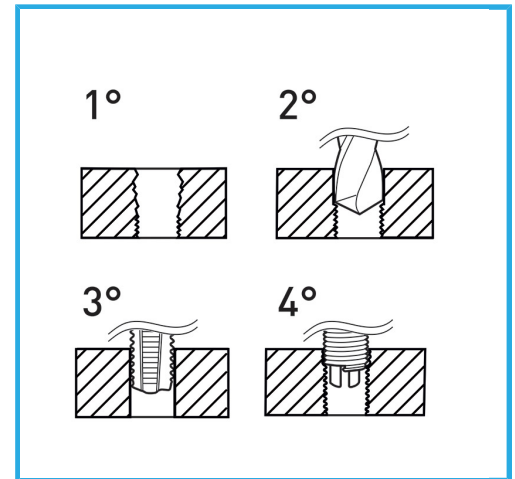

Gewindeinsatz	M6
Bohrer	6,3 mm
Gewindebohrer	x M6
Handgriff	2
Bruttogewicht	0,42 kg
EAN-Code	8012667249946



Aufhängbar

HSS



INOX