

INDICADO PARA LA REGENERACIÓN DE ROSCAS O PARA OBTENER ROSCADOS MUY RESISTENTES EN MATERIALES BLANDOS.

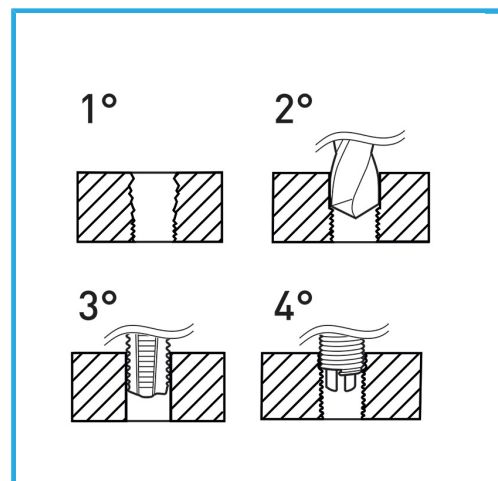

€30,90



Rosca inserta	M6
Broca	6,3 mm
Macho	x M6
Mango	2
Peso bruto	0,42 kg
Codigo de barras	8012667249946



Colgante

HSS



INOX