

ADATTI PER LA RIGENERAZIONE DELLE FILETTATURE O PER OTTENERE DELLE MASCHIATURE MOLTO RESISTENTI IN MATERIALI TENERI.

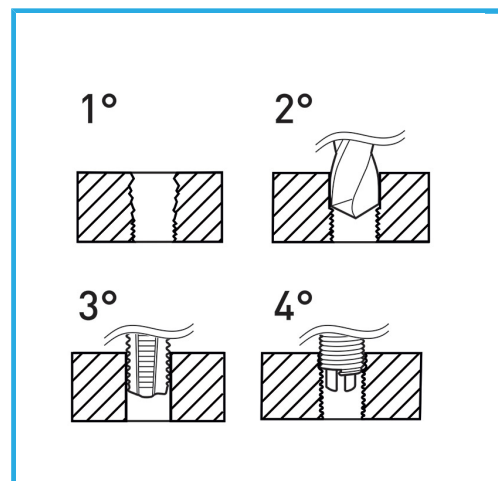

€30,90



Filetto inserto	M6
Punta	6,3 mm
Maschio	x M6
Manico	2
Peso lordo	0,42 kg
Codice EAN	8012667249946



Append.

HSS

INOX