

GEEIGNET ZUR GEWINDEREGENERATION ODER UM SEHR WIDERSTANDSFÄHIGES GEWINDESCHNEIDEN IN WEICHE MATERIALIEN ZU ERHALTEN.

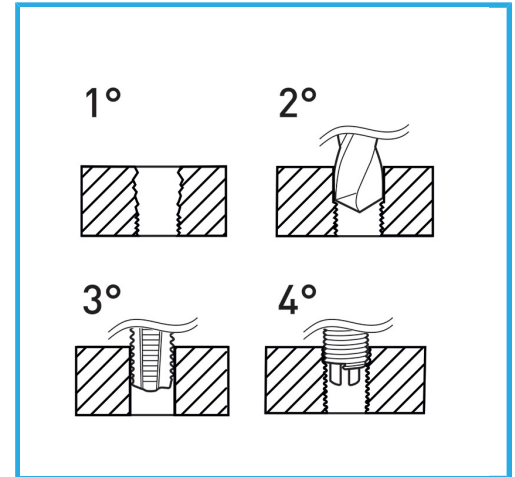

Gewindeinsatz	M8
Bohrer	8,3 mm
Gewindebohrer	x M8
Handgriff	2
Bruttogewicht	0,53 kg
Verpackungsmaße	160x115x40 h mm
EAN-Code	8012667249953



Aufhängbar

HSS

INOX