

SUITABLE FOR THREAD REGENERATION OR TO OBTAIN VERY RESISTANT TAPPING IN SOFT MATERIALS.

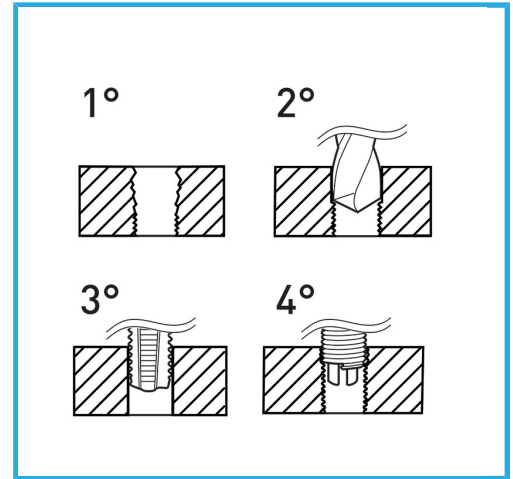

Thread insert	M8
Drill	8,3 mm
Tap	x M8
Handle	2
Gross weight	0,53 kg
EAN Code	8012667249953



Hangable

HSS

INOX