

ADATTI PER LA RIGENERAZIONE DELLE FILETTATURE O PER OTTENERE DELLE MASCHIATURE MOLTO RESISTENTI IN MATERIALI TENERI.

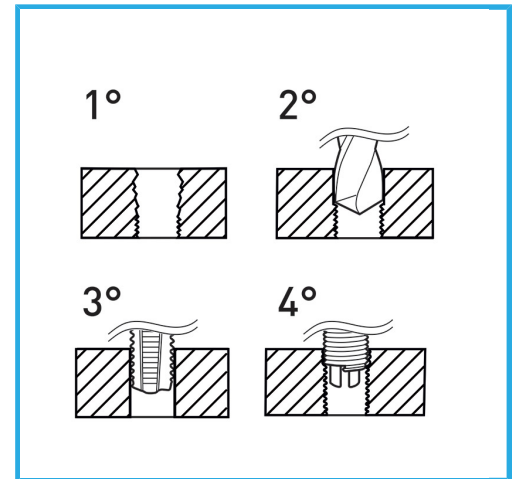

€34,00



Filetto inserto	M8
Punta	8,3 mm
Maschio	x M8
Manico	2
Peso lordo	0,53 kg
Codice EAN	8012667249953



Append.

HSS



INOX