

INDICADO PARA LA REGENERACIÓN DE ROSCAS O PARA OBTENER ROSCADOS MUY RESISTENTES EN MATERIALES BLANDOS.

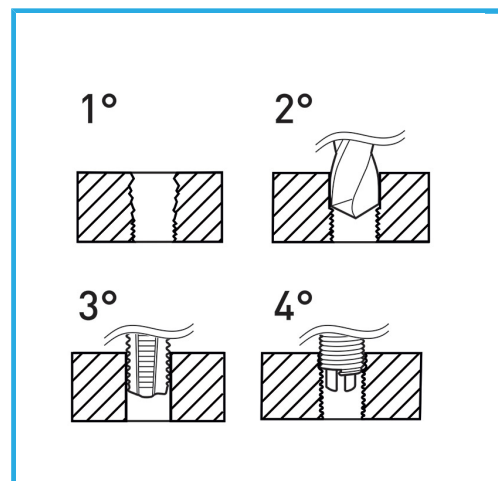

€43,50



Rosca inserta	M12
Broca	12,4 mm
Macho	x M12
Mango	2
Peso bruto	0,69 kg
Codigo de barras	8012667249977



Colgante

HSS



INOX