

ADATTI PER LA RIGENERAZIONE DELLE FILETTATURE O PER OTTENERE DELLE MASCHIATURE MOLTO RESISTENTI IN MATERIALI TENERI.

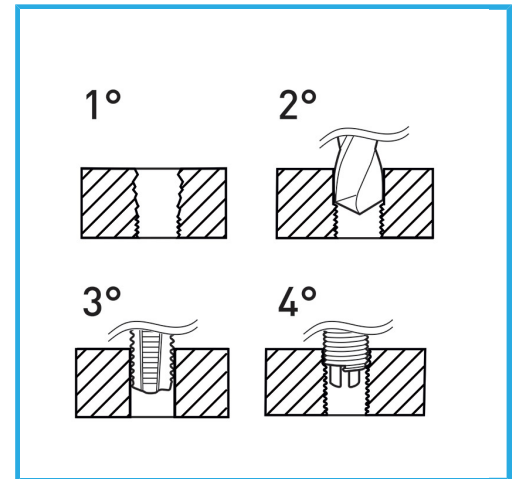

€43,50



Filetto inserto	M12
Punta	12,4 mm
Maschio	x M12
Manico	2
Peso lordo	0,69 kg
Codice EAN	8012667249977



Append.

HSS



INOX