

ART. 0855/T25
TORXSCHLÜSSEL MIT ANATOMISCHEM KUNSTSTOFFGRIFF

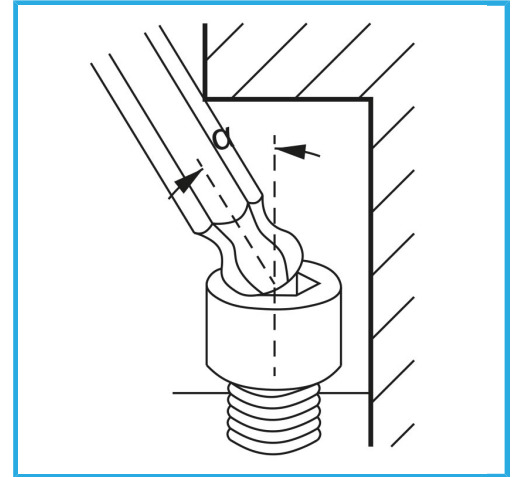

Maß	T25
Länge	100 mm
Bruttogewicht	0,04 kg
EAN-Code	8012667187019



Aufhängbar



Chrom



-



-