

€8,40

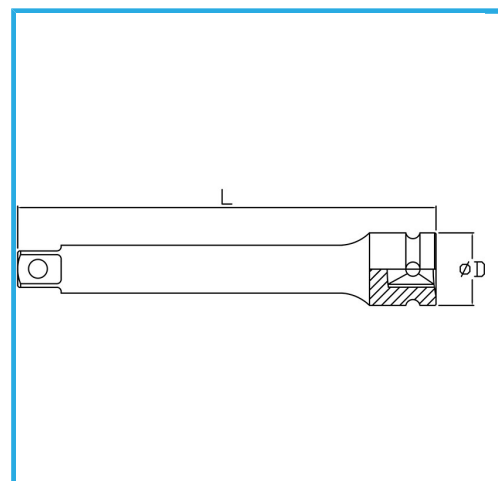

<b>D</b>	25 mm
<b>Lunghezza</b>	75 mm
<b>Peso lordo</b>	0,14 kg
<b>Codice EAN</b>	8012667273019



Fosfatata



1/2"



3121 - 3129



Cr-Mo -