

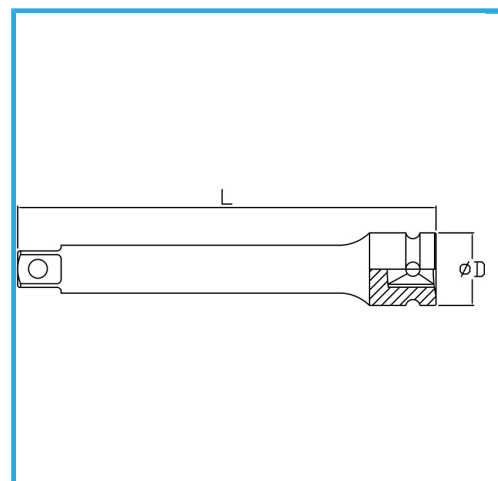

€9,10



D	25 mm
Longitud	125 mm
Peso bruto	0,23 kg
Codigo de barras	8012667273507



Fosfatado



1/2"



Cr-Mo