

DIN 3129.

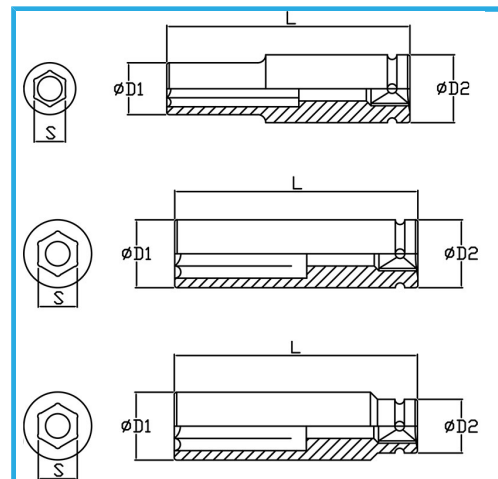

€19,80



Misura	22 mm
D1	36 mm
D2	44 mm
Lunghezza	90 mm
Peso lordo	0,61 kg
Dimensioni imballo	45x45x90 h mm
Codice EAN	8012667272470



Fosfatata



3/4"



Cr-Mo