

DIN 3129.

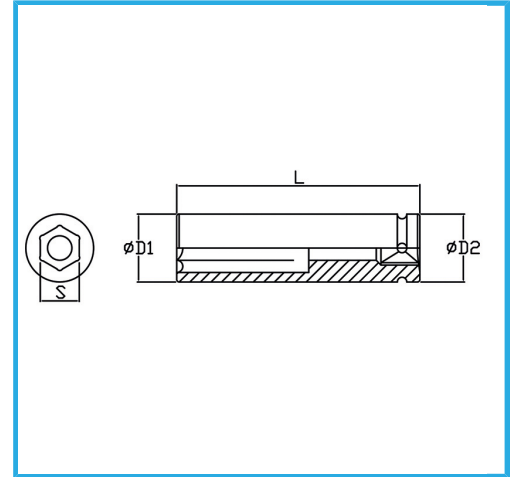

Size	24 mm
D1	42 mm
D2	54 mm
Length	90 mm
Gross weight	0,84 kg
EAN Code	8012667273231



Phosphated



1"



-



Cr-Mo