

DIN 3129.

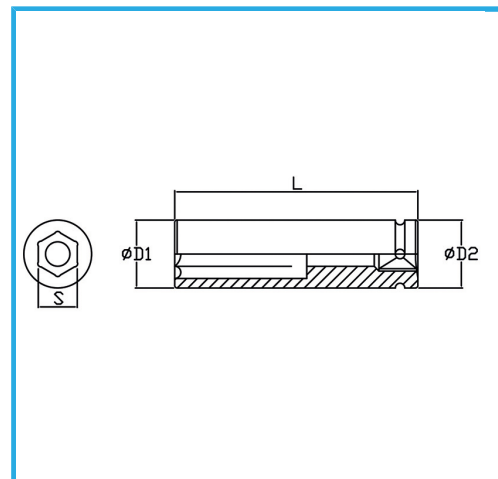

€28,50

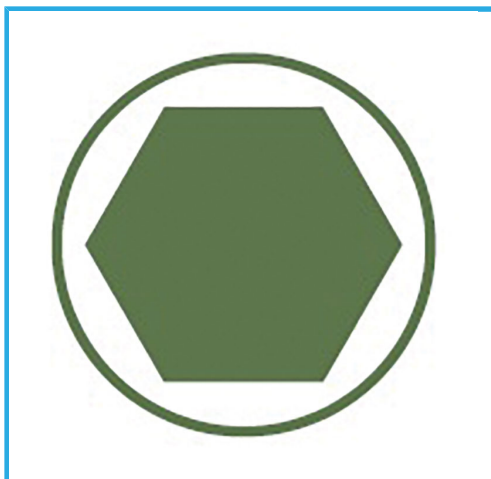

Misura	24 mm
D1	42 mm
D2	54 mm
Lunghezza	90 mm
Peso lordo	0,84 kg
Dimensioni imballo	44 x 44 x 90 h mm
Codice EAN	8012667273231



Fosfatata



1"



Cr-Mo