

DIN 3129.

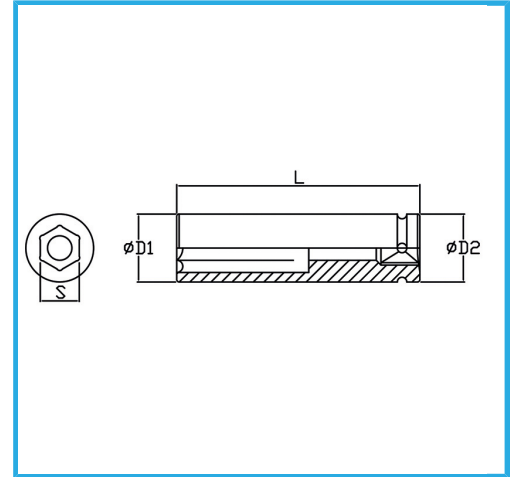

Size	27 mm
D1	46 mm
D2	54 mm
Length	90 mm
Gross weight	0,91 kg
EAN Code	8012667273248



Phosphated



1"



-



Cr-Mo