

DIN 3129.

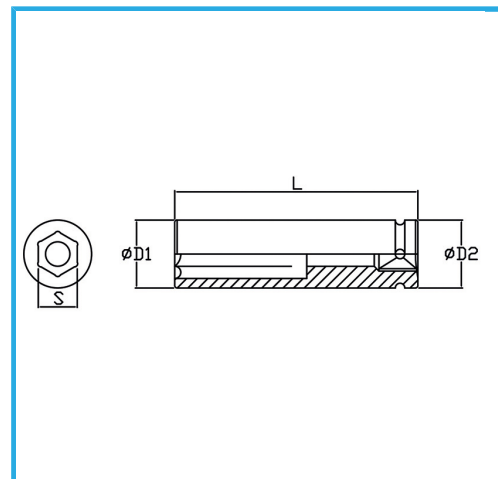

Size	30 mm
D1	49 mm
D2	54 mm
Length	90 mm
Gross weight	0,93 kg
EAN Code	8012667273262



Phosphated



1"



Cr-Mo