

DIN 3129.

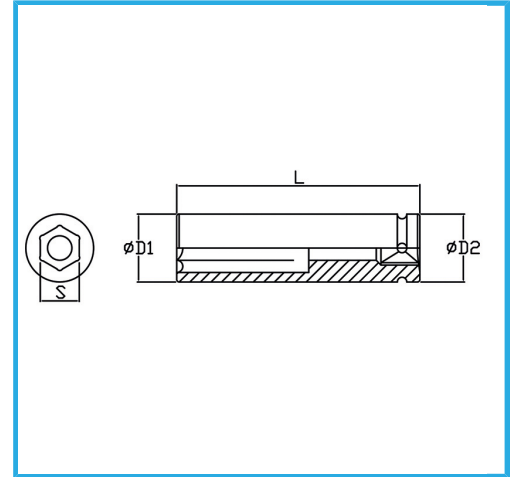

Size	32 mm
D1	52 mm
D2	54 mm
Length	90 mm
Gross weight	0,95 kg
EAN Code	8012667273279



Phosphated



1"



Cr-Mo