

DIN 3129.

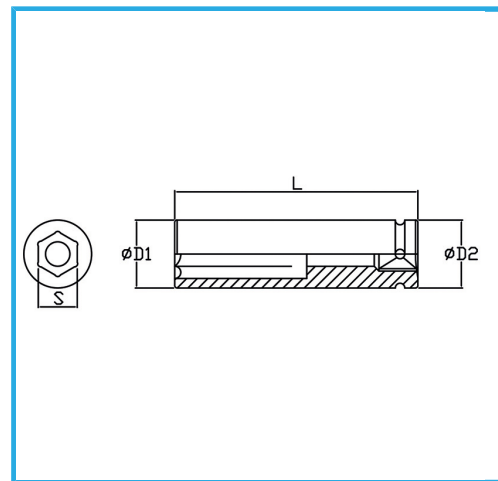

€28,50

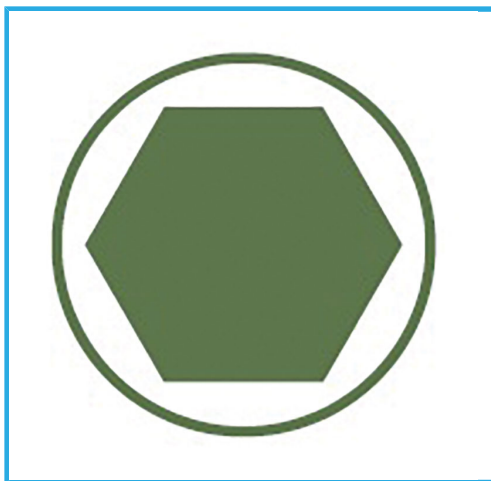

Misura	32 mm
D1	52 mm
D2	54 mm
Lunghezza	90 mm
Peso lordo	0,95 kg
Dimensioni imballo	55 x 55 x 90 h mm
Codice EAN	8012667273279



Fosfatata



1"



Cr-Mo