

DIN 3129.

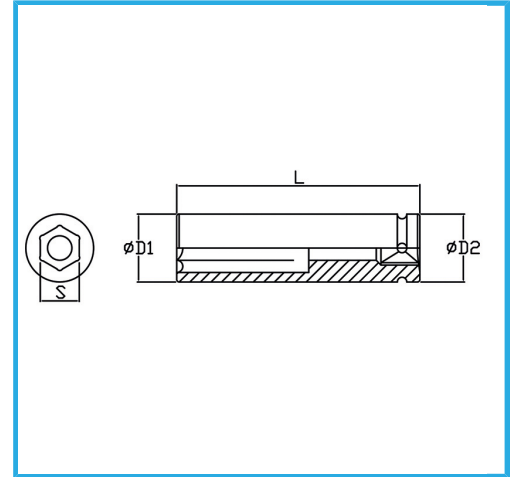

Size	35 mm
D1	54 mm
D2	54 mm
Length	90 mm
Gross weight	1,00 kg
EAN Code	8012667273309



Phosphated



1"



-



Cr-Mo