

DIN 3129.

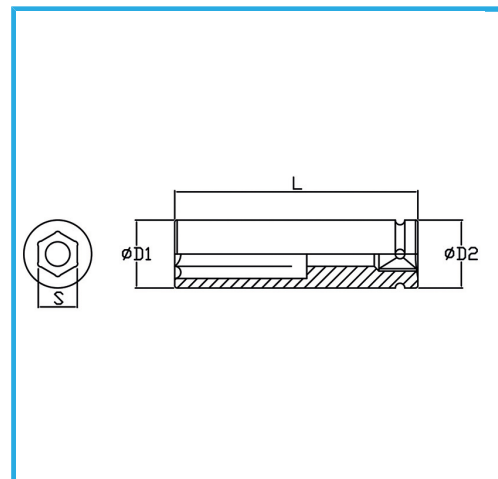

Size	36 mm
D1	56 mm
D2	54 mm
Length	90 mm
Gross weight	1,00 kg
EAN Code	8012667273316



Phosphated



1"



Cr-Mo