

DIN 3129.

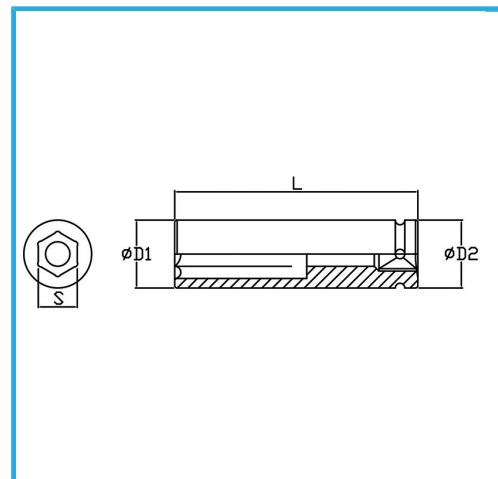

€29,00

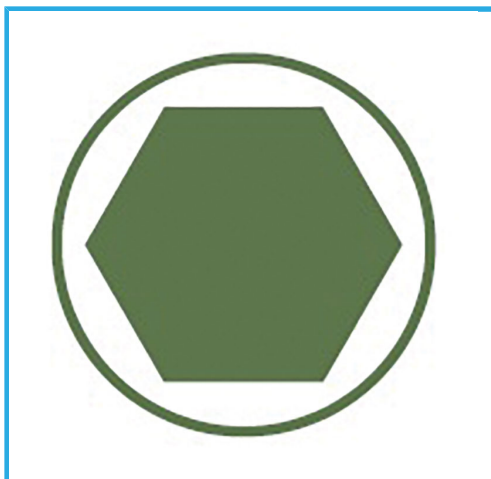

Misura	36 mm
D1	56 mm
D2	54 mm
Lunghezza	90 mm
Peso lordo	1,00 kg
Dimensioni imballo	110x60x150 h mm
Codice EAN	8012667273316



Fosfatata



1"



Cr-Mo