

DIN 3129.

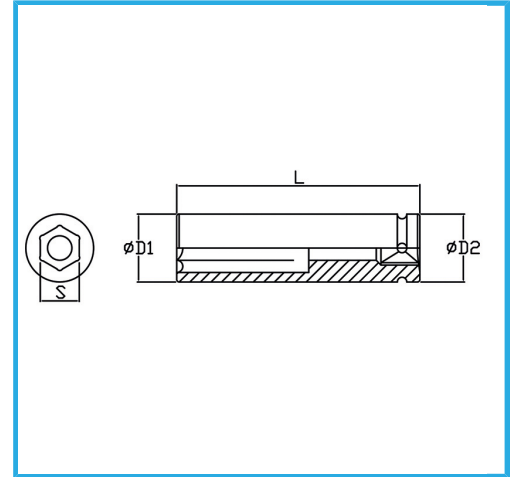

Size	38 mm
D1	58 mm
D2	54 mm
Length	95 mm
Gross weight	1,15 kg
EAN Code	8012667273323



Phosphated



1"



-



Cr-Mo