

DIN 3129.

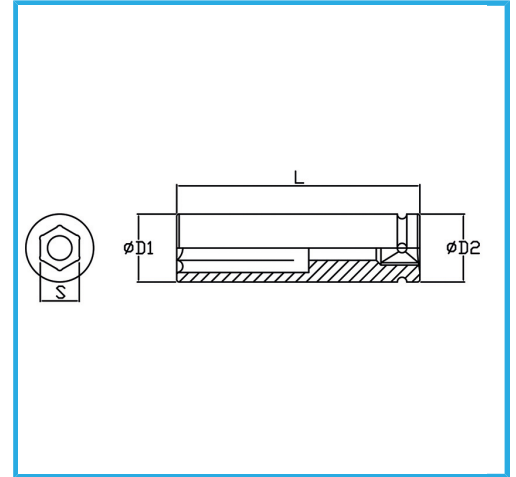

Size	41 mm
D1	61 mm
D2	54 mm
Length	95 mm
Gross weight	1,22 kg
EAN Code	8012667273354



Phosphated



1"



-



Cr-Mo